



CUSTOM CONNECTOR CORPORATION

# Relay Sockets

•UL recognized, File No. E60008

•CSA certified, File No. LR29513



Mfr.'s Type	Description	Terminal Type
<b>RB08</b>	DPDT, 8 Pin Octal (Fig. 1)	Binder Head Screws
<b>RB08-PC</b>	DPDT, 8 Pin Octal (Fig. 1)	Pressure Clamp Screws
<b>RB11</b>	3PDT, 11 Pin Octal (Fig. 2)	Binder Head Screws
<b>RB11-PC</b>	3PDT, 11 Pin Octal (Fig. 2)	Pressure Clamp Screws

ELECTRICAL RATING: • RB08, RB08-PC - 600 Volts, 10 Amps  
• RB11, RB11-PC - 300 Volts, 10 Amps

Fig. 1

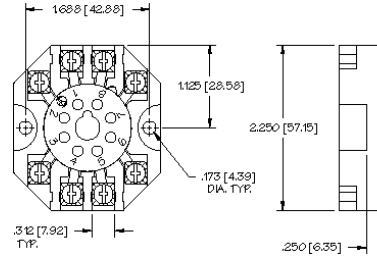
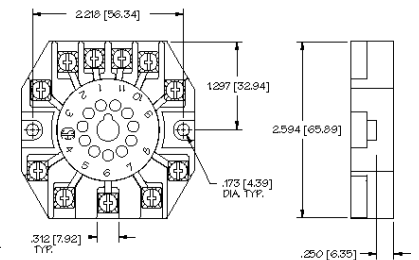

Fig. 2



Mfr.'s Type	Description	Terminal Type
<b>OB08-PCB</b>	DPDT, 8 Pin Octal (Fig. 1)	PC Board
<b>OB11-PCB</b>	3PDT, 11 Pin Octal Style (Fig. 2)	PC Board

ELECTRICAL RATING: • 300 Volts, 10 Amps

Fig. 1

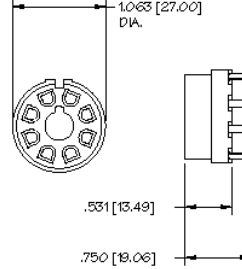
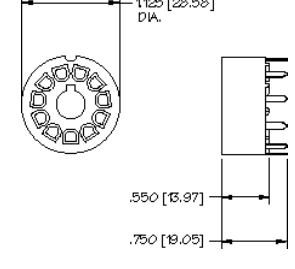
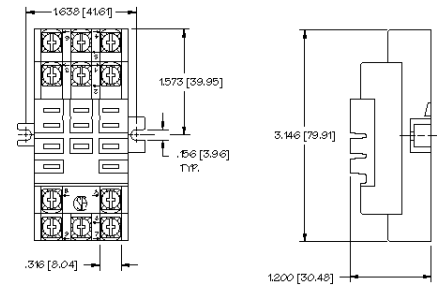

Fig. 2



Mfr.'s Type	Description	Terminal Type
<b>QC08</b>	DPDT, 8 Pin Square	Binder Head Screws
<b>QC08-PC</b>	DPDT, 8 Pin Square	Pressure Clamp Screws
<b>QC11</b>	3PDT, 11 Pin Square	Binder Head Screws
<b>QC11-PC</b>	3PDT, 11 Pin Square	Pressure Clamp Screws

ELECTRICAL RATING: • 300 Volts, 10 Amps • 150 Volts, 15 Amps



ACCESSORY

**HDB-3** ..... Hold Down Spring



Mfr.'s Type	Description	Terminal Type
<b>SS08</b>	DPDT, 8 Pin Square	Binder Head Screws
<b>SS08-PC</b>	DPDT, 8 Pin Square	Pressure Clamp Screws
<b>SS11</b>	3PDT, 11 Pin Square	Binder Head Screws
<b>SS11-PC</b>	3PDT, 11 Pin Square	Pressure Clamp Screws

ELECTRICAL RATINGS: • 300 Volts, 10 Amps • 150 Volts, 15 Amps

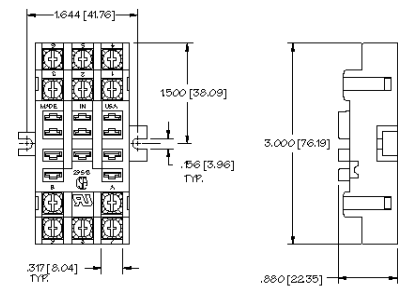

ACCESSORY

**HDB-8** ..... Hold Down Spring



Mfr.'s Type	Description	Terminal Type
<b>SD12</b>	12 Pin (Fig. 1)	Binder Head Screws
<b>SD12-PC</b>	12 Pin (Fig. 1)	Pressure Clamp Screws
<b>SD14</b>	14 Pin (Fig. 2)	Binder Head Screws
<b>SD14-PC</b>	14 Pin (Fig. 2)	Pressure Clamp Screws

ELECTRICAL RATINGS: • SD12, SD14 - 600 Volts, 10 Amps  
• All others - 300 Volts, 10 Amps

Fig. 1

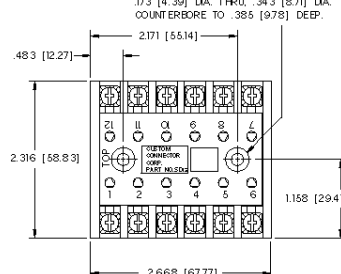
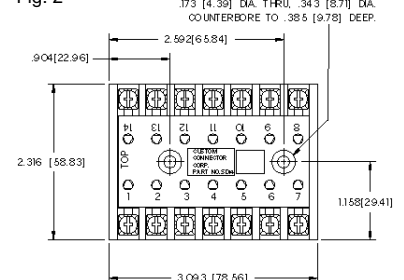

Fig. 2





CUSTOM CONNECTOR CORPORATION

# Relay Sockets

• ULrecognized, File No. E60008  
• CSAcertified, File No. LR29513

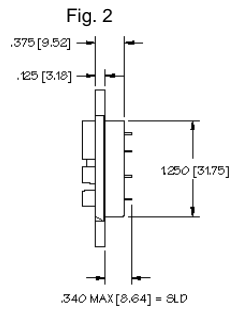
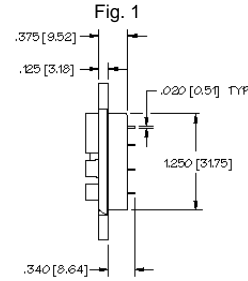
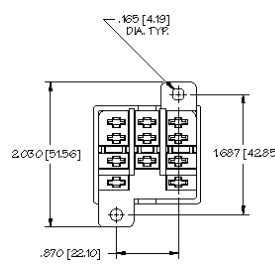

Mfr.'s Type	Description	Terminal Type
CM08-SLD	DPDT, 8 Pin Square (Fig. 2)	Solder
CM08-QDC	DPDT, 8 Pin Square (Fig. 1)	Quick Disconnect
CM11-SLD	3PDT, 11 Pin Square (Fig. 2)	Solder
CM11-QDC	3PDT, 11 Pin Square (Fig. 1)	Quick Disconnect

ELECTRICALRATING: • 300 Volts, 10 Amps • 150 Volts, 15 Amps

ACCESSORY

HDB-5 ..... Hold Down Spring



Mfr.'s Type	Description	Terminal Type
CM08-PCB-1S	DPDT, 8 Pin Square, No Mount Ends (Fig. 2)	PC Board
CM08-PCB	DPDT, 8 Pin Square (Fig. 1)	PC Board
CM08-LPCB-1S	DPDT, 8 Pin Square, No Mount Ends (Fig. 2)	Long PC Board
CM08-LPCB	DPDT, 8 Pin Square, (Fig. 1)	Long PC Board
CM11-PCB-1S	3PDT, 11 Pin Square, No Mount Ends (Fig. 2)	PC Board
CM11-PCB	3PDT, 11 Pin Square (Fig. 1)	PC Board
CM11-LPCB-1S	3PDT, 11 Pin Square, No Mount Ends (Fig. 2)	Long PC Board
CM11-LPCB	3PDT, 11 Pin Square, (Fig. 1)	Long PC Board

ELECTRICALRATING: • 300 Volts, 10 Amps • 150 Volts, 15 Amps

ACCESSORY

HDB-5 ..... Hold Down Spring

Fig. 1

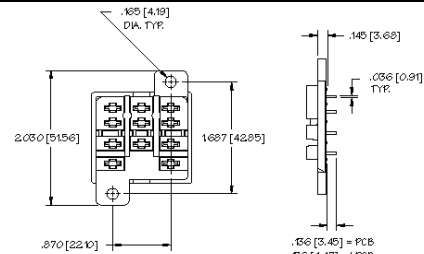
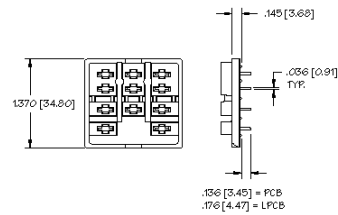

Fig. 2



Mfr.'s Type	Description	Terminal Type
MR08-PCB	DPDT, 8 Pin Miniature (Fig. 1)	PC Board
MR08-PCB-1G	DPDT, 8 Pin Miniature (Fig. 1)	PC Board, Ground Lug Omitted
MR08-PCB-1G N	DPDT, 8 Pin Miniature (Fig. 3)	PC Board
MR08-SLD	DPDT, 8 Pin Miniature (Fig. 2)	Solder
MR08-SLD-1G	DPDT, 8 Pin Miniature (Fig. 2)	Solder, Ground Lug Omitted
MR14-PCB	4PDT, 14 Pin Miniature (Fig. 1)	PC Board
MR14-PCB-1G	4PDT, 14 Pin Miniature (Fig. 1)	PC Board, Ground Lug Omitted
MR14-PCB-1G N	4PDT, 14 Pin Miniature (Fig. 3)	PC Board
MR14-SLD	4PDT, 14 Pin Miniature (Fig. 2)	Solder
MR14-SLD-1G	4PDT, 14 Pin Miniature (Fig. 2)	Solder, Ground Lug Omitted

ELECTRICALRATING: • 300 Volts, 5 Amps

ACCESSORY

HDB-4 ..... Hold Down Spring

HDB-9 ..... Hold Down Spring

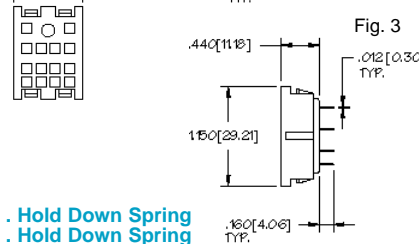
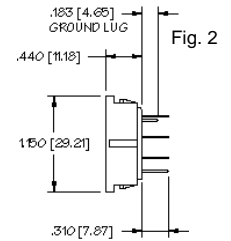
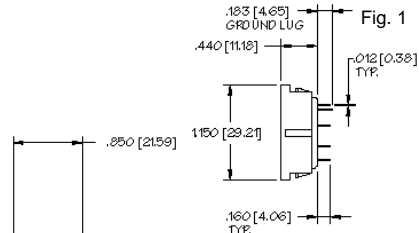

Mfr.'s Type	Description	Terminal Type
GR108-PCB	DPDT, 8 Pin Midget (Fig. 2)	PC Board
GR108-SLD	DPDT, 8 Pin Midget (Fig. 3)	Solder
GR108-PC	DPDT, 8 Pin Midget (Fig. 1)	Pressure Clamp Screws

ELECTRICALRATING: • GR108-PCB & SLD - 300 Volts, 10 Amps  
• GR108-PC - 300 Volts, 10 Amps  
150 Volts, 15 Amps

ACCESSORY

HDB-4 ..... Hold Down Spring

HDB-9 ..... Hold Down Spring

Fig. 1

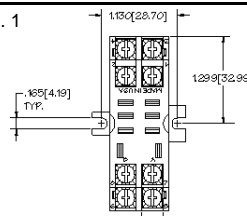

Fig. 2

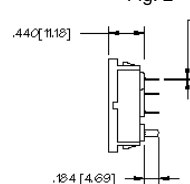
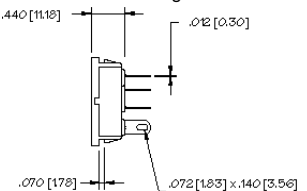

Fig. 3





CUSTOM CONNECTOR CORPORATION



# Relay Sockets

UL recognized, File No. E113714  
CSA certified, File No. LR26716

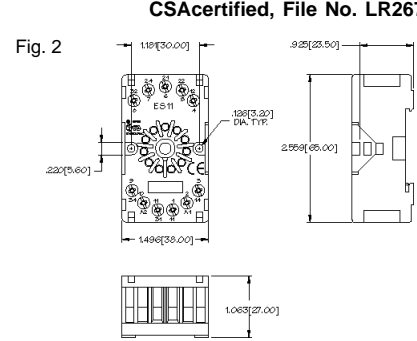
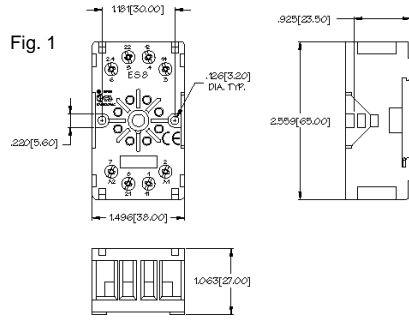
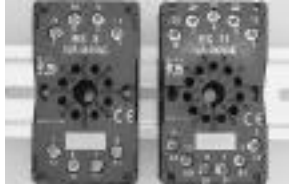

Mfr.'s Type	Description	Terminal Type
ES8	DPDT, 8 Pin Octal (Fig. 1)	Box Lug
ES11	3PDT, 8 Pin Octal (Fig. 2)	Box Lug

ACCESSORY

HDB-13 ..... Hold Down Spring  
T ..... Marking Plate

ELECTRICAL RATING: • 300 Volts, 10 Amps

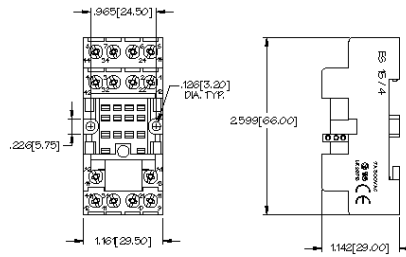
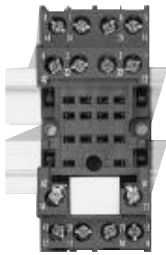

Mfr.'s Type	Description	Terminal Type
ES15/4	4PDT, 14 Pin Miniature	Pressure Clamp Screws

ACCESSORY

MHO ..... Hold Down Spring  
Plug-in indicator and protection modules available

ELECTRICAL RATING: • 300 Volts, 7 Amps

Fig. 1

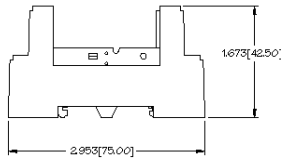
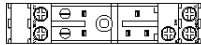
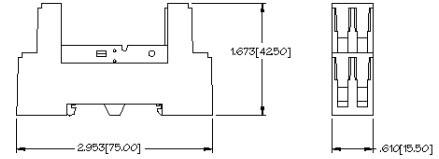
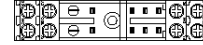

Fig. 2



Mfr.'s Type	Description	Terminal Type
ES35	SPDT, 5 Pin Slim Line (Fig. 1)	Box Lug
ES50	DPDT, 8 Pin Slim Line (Fig. 2)	Box Lug

ACCESSORY

MH12-2 ..... Hold Down Spring  
MH16-2 ..... Hold Down Spring  
MH25-2 ..... Hold Down Spring  
Plug-in indicator and protection modules available

ELECTRICAL RATING: • 300 Volts, 12 Amps

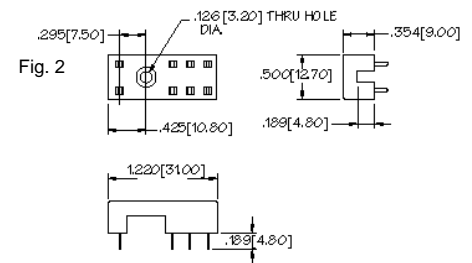
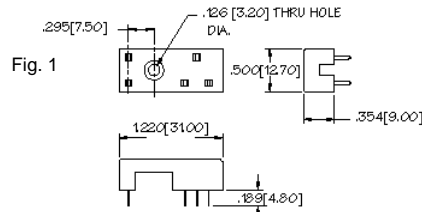
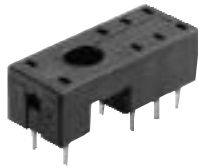

Mfr.'s Type	Description	Terminal Type
EC35	SPDT, 5 Pin Slim Line (Fig.1)	PC Board
EC50	DPDT, 8 Pin Slim Line (Fig.2)	PC Board

ACCESSORY

MH12-2 ..... Hold Down Spring  
MH16-2 ..... Hold Down Spring  
MH25-2 ..... Hold Down Spring

ELECTRICAL RATINGS: • 300 Volts, 12 Amps



# Automotive Relay Sockets

CUSTOM CONNECTOR CORPORATION



Fig. 6

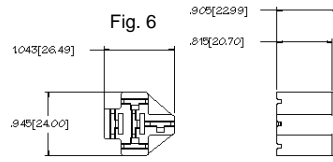

Fig. 5

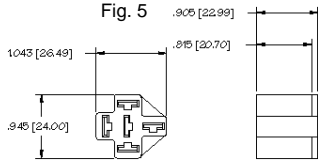

Fig. 4

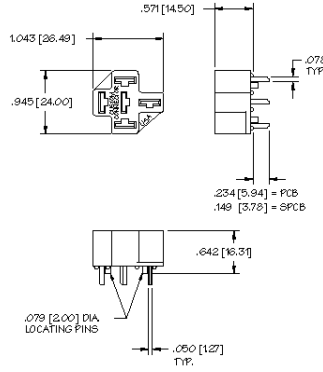
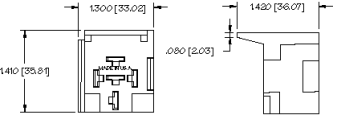

Fig. 1 PC BOARD LAYOUT

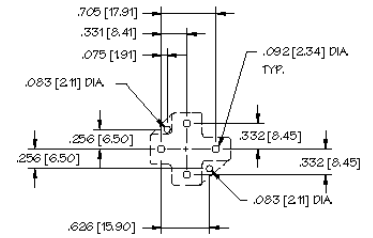

Fig. 2 PC BOARD LAYOUT

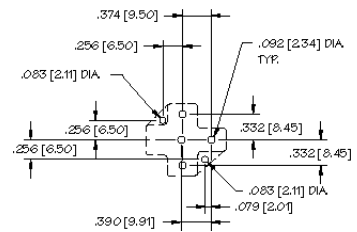
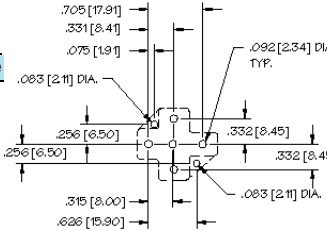

Fig. 3 PC BOARD LAYOUT



Mfr.'s Type	Description	Terminal Type
BR04-PCB-0	4 Pin (Fig 1)	PC Board
BR04-PCB-T	4 Pin (Fig. 2)	PC Board
BR05-PCB	5 Pin (Fig. 3)	PC Board
BR05-PCB-1P	5 Pin Without Locator Pins (Fig. 3)	PC Board
BR05-SPCB	5 Pin (Fig. 3)	PC Board
BR05-SPCB-1P	5 Pin Without Locator Pins (Fig. 3)	PC Board
BR05-FW 5 Pin	5 Pin Connector for Wire Harnessing (Fig. 4)	Crimp
BR05-WH 5 Pin	5 Pin Connector for Wire Harnessing (Fig. 5)	Crimp
BR05-WHF	5 Pin Relay or Flasher Connector for Wire Harnessing (Fig.6)	Crimp

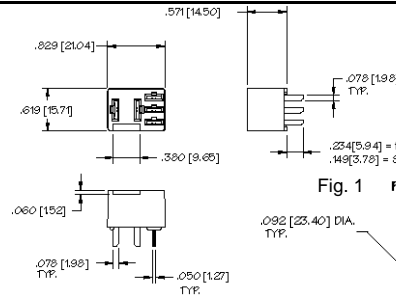
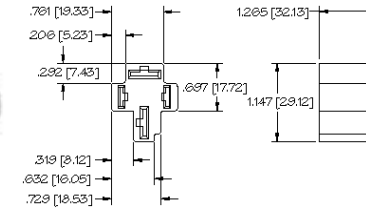

Fig. 1 PC BOARD LAYOUT

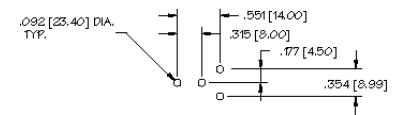

Fig. 2 PC BOARD LAYOUT

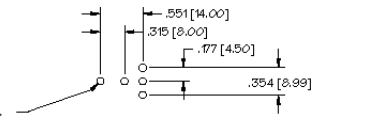

Fig. 3

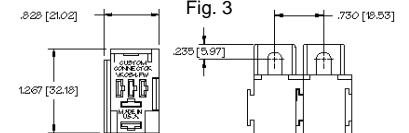
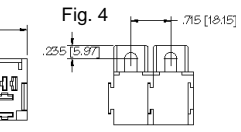

Fig. 4



Mfr.'s Type	Description	Terminal Type
PR04-WH	4 Pin Automotive Connector for Wire Harnessing	Crimp

## ELECTRONIC PACKAGING PRODUCTS, HEADERS AND ENCLOSURES

Mfr.'s Type	Description	Terminal Type
VR04-PCB-0	4 Pin Automotive (Fig. 1)	PC Board
VR05-PCB	5 Pin Micro Automotive (Fig. 2)	PC Board
VR05-LFW	5 Pin Micro Automotive (Fig. 3)	Crimp
VR05-FW	5 Pin Micro Automotive (Fig. 4)	Crimp

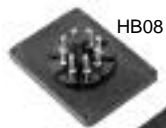

HB08

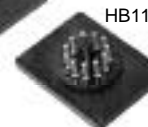

HB11



FC SERIES

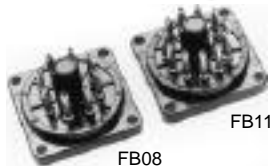

FB08

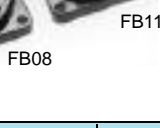

FB11



HC,DC,JC SERIES

C1BV2020



E1BV2020  
E1BV2020H

E1BV2525

E2BV4530



E2BV2720

Mfr.'s Type	Description	Dimensions
FB08	8 Pin Octal Style Male Header	1.375" X 1.375"
FB11	11 Pin Octal Style Male Header	1.375" X 1.375"
FCBP, FCCP, FCWP	Enclosures	1.375" x 1.375" x 1.925
HB08	8 Pin Octal Style Male Header	2.375" x 1.75"
HB11	11 Pin Octal Style Male Header	2.375" x 1.75"
HCBP, HCCP, HCWP	Enclosures	2.375" x 1.75" x 2.625"
JCBP, JCCP, JCWP	Enclosures	2.375" x 1.75" x 3.313"
DCBP, DCCP, DCWP	Enclosures	2.375" x 1.75" x 2.750"
HMS-1	Header Mounting Screw	Header Mounting Screw

Mfr.'s Type	Description	Dimensions
E1BV2020	Enclosure	2.022" X 2.022" X .750"
E1BV2020H	Enclosure w/ molded in heat sinc	2.022" X 2.022" X .750"
E1BV2525	Enclosure	2.513" x 2.513" x .750"
C1BV2020	Cover for E1BV2020	2.022" x 2.022"
E2BV2720	Enclosure	2.00" x 2.700" x .825"
E2BV4530	Enclosure	3.00" x 4.500" x .825"



soctec

# Relay Sockets

•ULrecognized, File No. E60008  
•CSAcertified, File No. LR29513

CUSTOM CONNECTOR CORPORATION

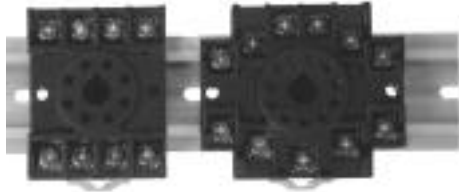

Fig. 1

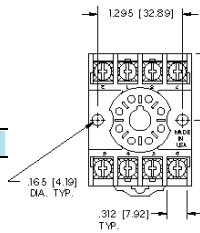
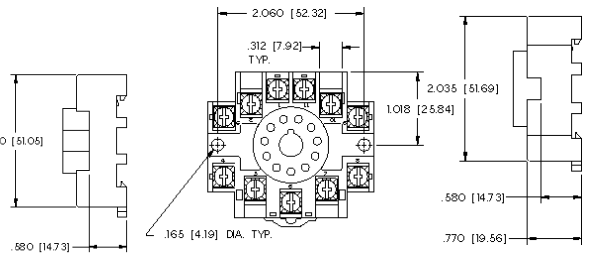
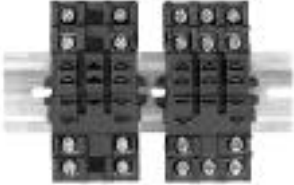

Fig. 2



Mfr.'s Type	Description	Terminal Type
<b>OT08</b>	DPDT, 8 Pin Octal (Fig. 1)	Binder Head Screws
<b>OT08-PC</b>	DPDT, 8 Pin Octal (Fig. 1)	Pressure Clamp Screws
<b>OT11</b>	3PDT, 11 Pin Octal (Fig. 2)	Binder Head Screws
<b>OT11-PC</b>	3PDT, 11 Pin Octal (Fig. 2)	Pressure Clamp Screws

Electrical Rating: •OT08 - 600 Volts, 10 Amps  
•All others - 300 Volts, 10 Amps



Mfr.'s Type	Description	Terminal Type
<b>ST08</b>	DPDT, 8 Pin Blade	Binder Head Screws
<b>ST08-PC</b>	DPDT, 8 Pin Blade	Pressure Clamp Screws
<b>ST11</b>	3PDT, 11 Pin Blade	Binder Head Screws
<b>ST11-PC</b>	3PDT, 11 Pin Blade	Pressure Clamp Screws

Electrical Rating: •300 Volts, 15 Amps

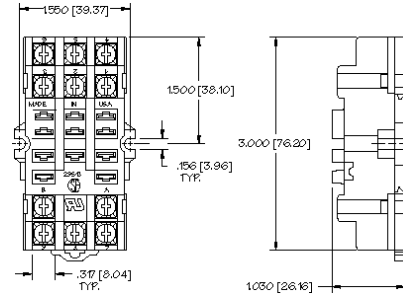

ACCESSORY

**HDB-8** ..... Hold Down Spring

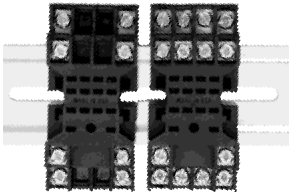

Mfr.'s Type	Description	Terminal Type
<b>MT08-PC</b>	DPDT, 8 Pin Miniature	Pressure Clamp Screws
<b>MT14-PC</b>	4PDT, 14 Pin Miniature	Pressure Clamp Screws

Electrical Rating: •300 Volts, 7 Amps

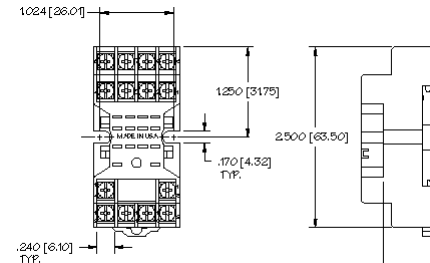

ACCESSORY

**HDB-4** ..... Hold Down Spring



Mfr.'s Type	Description	Terminal Type
<b>GT08-PC</b>	DPDT, 8 Pin Midget	Pressure Clamp Screws

Electrical Rating: •300 Volts, 10 Amps  
•150 Volts, 15 Amps

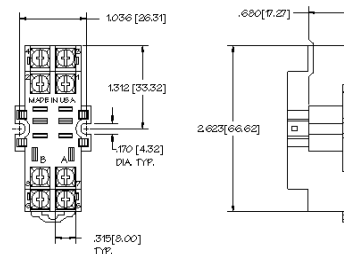

ACCESSORY

**HDB-4** ..... Hold Down Spring

**C-103-PM** prepunched aluminum  
DIN rail (1 meter lengths)

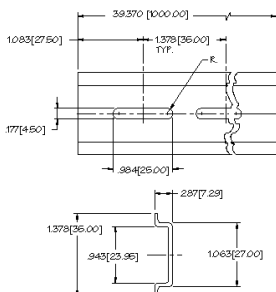

**C-104-PM** prepunched steel  
DIN rail (1 meter lengths)

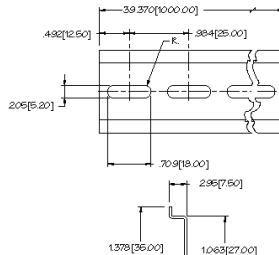

**C-105-PM** prepunched steel  
DIN rail (1 meter lengths)

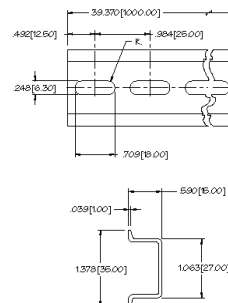

**C-106-2PM** prepunched steel  
DIN rail (2 meter lengths)

